

POCKET DOOR

PD-75

STANLEY 99-3900

Pocket Door Hardware Assembly and Installation Instructions

We Supply:
This package contains all the necessary hardware components for installation of your Pocket Door.

For Pocket Hardware Set:
40-3903 (A) 40-3904 (A)

See Contents:

1—Gold-Tone Steel Track*

2—Adjustable Hangers

1—Adjusting Wrench

1—Door Guide

1—Bumper Stop

*All necessary fasteners
—Track is less than opening to reduce need to cut track.

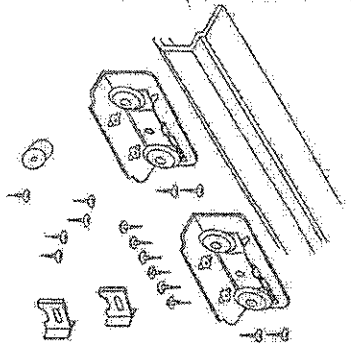

You Supply:
Door Panel as specified on the package chart, Phillips Screwdriver, Tape Measure, Hammer, Drill with 3/8" and 1/8" Bits.

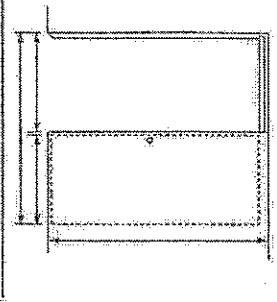

How to Install your Pocket Door:
Please read the complete instructions carefully. Before you start installation, this track and hardware system may be used for a Pocket Door. (In the usual installation, instructions are for Pocket Door installation rough opening.)

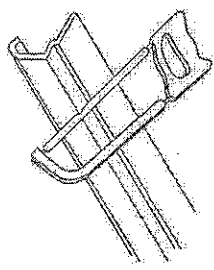

1. Cut track:
If necessary, cut track to 1/8" less than the width of the rough opening. Use a fine tooth back saw.

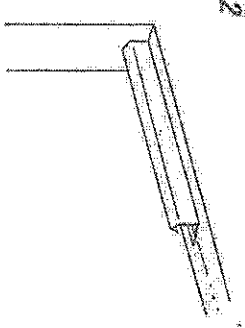

2. Install track:
Align the center of the track with the center of the header and attach with the screws provided.

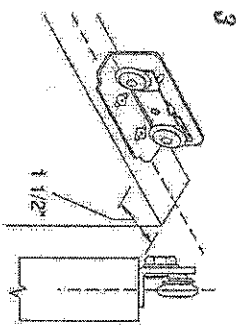

3. Install hangers:
Position the adjustable door hangers on the top of the door panel. Hangers should be approximately 1-1/2" from door edges with wheels seated along center line of door.

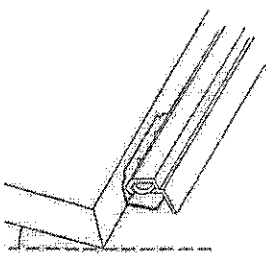

4. Install door:
Lift the door into the track. Door must be angled approximately 15° to engage in track.

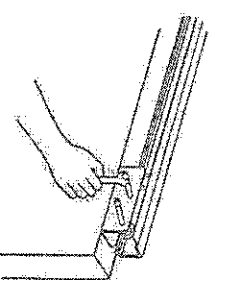

5. Adjust door:
Using the wrench included, adjust hangers so that door is flush with the jamb and has proper floor clearance. Clockwise turns will raise the door, counterclockwise turns will lower the door. This adjustment is self-feeding.

