

INSTRUCTIONS FOR CUTTING 600 SERIES CONTINUOUS HINGES

STEP 1 - Determine Hinge Height

- Measure height of opening from finished floor to underside of door frame header.
- Hinge height is height of opening MINUS 7/8 inch.

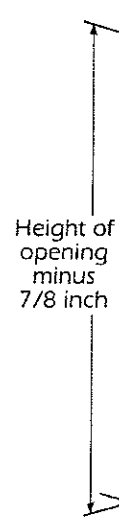

STEP 2 - Mark Hinge for Cutting

- Determine which end of hinge will be the TOP using door and frame as a guide.
- Open hinge to expose back of hinge (holes are NOT countersunk).
- Measure hinge height calculated in step 1 from TOP of hinge.
- Using square, mark a line on back of both hinge leaves and the barrel.

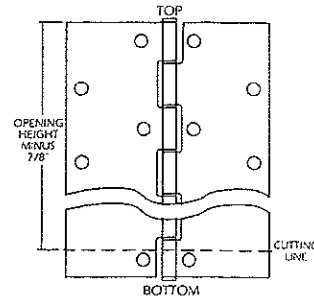

DOUBLE CHECK MEASUREMENT BEFORE CUTTING!
NOTE: cut end of hinge must be used as BOTTOM OF HINGE ONLY!

STEP 3 - Cut Hinge

- Fold hinge so that cut line is visible.
- Starting on barrel, cut through entire hinge along line.
- Debur all cut edges with file.
- Use center punch or heavy gauge nail on pin in short cut off portion of hinge to remove hinge tip. SAVE HINGE TIP for use in step 5.

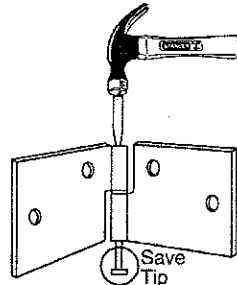
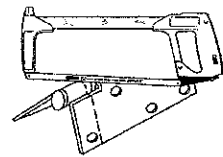

STEP 4 - Shorten Hinge Pin 3/4"

- Using center punch or heavy nail, tap on cut surface of hinge pin to remove top hinge tip (Save tip for Step 5).
- Expose 1" of hinge pin. Measure and mark 3/4 inch from end of pin. DOUBLE CHECK MEASUREMENT BEFORE CUTTING.
- Cut pin at mark.

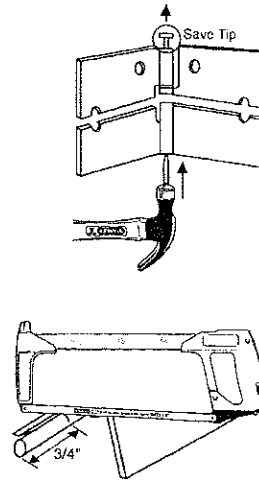

STEP 5 - Insert Top & Bottom Tip

- Tap hinge pin back into barrel.
- Tap hinge pin tips retained from step 3 & 4 above firmly into top & bottom of barrel until shoulder sits squarely on barrel. NOTE both tips MUST BE INSTALLED to hold hinge pin in position.

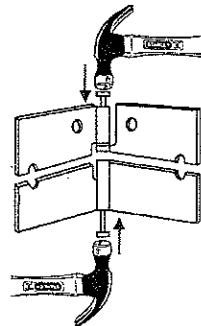

IMPORTANT NOTE:

IF MORE THAN 6 INCHES IS CUT FROM BOTTOM OF HINGE, ADDITIONAL MOUNTING HOLES WILL BE REQUIRED ON BOTTOM OF HINGE. USE CUT OFF PIECE OF HINGE TO MARK AND PREPARE HOLE LOCATIONS ON BOTTOM OF HINGE.

INSTALLATION INSTRUCTIONS FOR MODELS 647, 657

PACKAGE INCLUDES

- 1 Hinge
 - 1/4-20 x 3/4" self drilling screw for metal doors & frames
 - Screw cover clips
 - 2 screw covers
- | | 7" hinge | 8" hinge | 10" hinge |
|----------------------------|----------|----------|-----------|
| number of screws/clips for | 26 | 28 | 40 |
| | 12 | 16 | 18 |

TOOLS NEEDED

- 12' tape measure
- #2 pt. Phillips head screw driver bit
- 3/8" power drill or screw gun
- marking pen
- Square for marking hinge cut off line
- Rubber mallet
- Center punch
- Metal cutting saw (if hinge must be cut to fit door or frame)
- Angled block or similar device for holding door in position
- Hammer
- Flat file

INSTRUCTIONS FOR INSTALLING MODELS 647, 657

NOTE: before proceeding, check to be sure that hinge is proper size. Height of hinge should be 7/8 inch LESS than opening height. See other side of page for cutting instructions.

STEP 1 - Mount Hinge to Frame

- Place frame leaf of hinge on face of frame so that there is 1/8 inch gap between the top of the hinge leaf and the underside of the frame header and 1/16 inch gap between the edge of the frame and the center line of the hinge barrel. CHECK TO BE SURE HINGE LEAF IS SQUARE TO FRAME WITH 1/16 INCH GAP FROM EDGE OF FRAME TO CENTERLINE OF HINGE BARREL THE FULL LENGTH OF THE HINGE.
- With hinge held firmly and accurately to frame, place 1/4-20 x 3/4 inch self drilling screws through cover clips and screw into frame through mounting holes in hinge leaf. Cover clips should be located at the top and bottom mounting holes, and equally spaced along the length of the frame leaf.
- Install remaining 1/4-20 x 3/4 inch self drilling screws through mounting holes in frame.

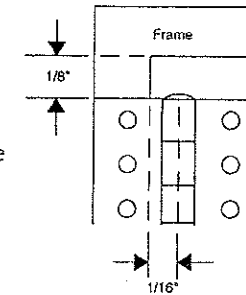

ALL HOLE LOCATIONS ON HINGE LEAF MUST BE FASTENED TO FRAME FOR PROPER OPERATION. FAILURE TO INSTALL ALL FASTENERS WILL VOID WARRANTY AND UL FIRE LABEL LISTINGS.

NOTE: FOR THIN METAL FRAMES (18 GAUGE OR THINNER) THE USE OF SELF CLAMPING TYPE FASTENERS SUCH AS JACK NUTS IS RECOMMENDED

STEP 2 - Mount Hinge to Door

- IMPORTANT NOTE:** FOR ALL UL FIRE LABEL DOORS, 1/4-20 X 1 3/4 INCH STEEL THROUGH BOLTS MUST BE USED FOR FASTENING THE HINGE TO THE DOOR.
- Move door into opening and place door leaf of hinge on face of door so that top of door is flush with top of hinge and center line of hinge barrel is 1/16 inch from edge of door.
 - With hinge held firmly and accurately to door, place 1/4-20 x 3/4 inch self drilling screws through cover clips and screw into door through mounting holes in door leaf. Cover clips should be located at the top and bottom mounting holes, and equally spaced along the length of the door leaf.
 - Install remaining 1/4-20 x 3/4 inch self drilling screws through mounting holes in door leaf.

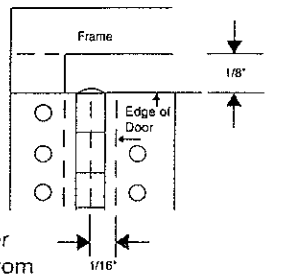

ALL HOLE LOCATIONS ON HINGE LEAF MUST BE FASTENED TO DOOR FOR PROPER OPERATION. FAILURE TO INSTALL ALL FASTENERS WILL VOID WARRANTY AND UL FIRE LABEL LISTINGS.

STEP 3 - Check for Proper Operation

- Close door and check for proper operation and clearances.

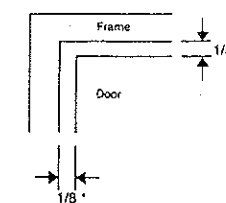

STEP 4 - Mount Screw Covers

- After door has been checked for proper operation and all mounting screws have been tightened, engage short leg of cover to barrel side of clip.
- Tap cover onto outside clip with rubber mallet so that long leg of cover sits against frame or door surface. DO NOT DAMAGE COVER.

